



TYNTEK Corporation

鼎元光電科技股份有限公司



ACE Royal Tech Inc.

T. 031-905-0968 F. 02-6230-9269
<http://www.aceroyal.co.kr>
e-mail; marketing@aceroyal.co.kr



鼎元光電科技股份有限公司
TYNTEK CORPORATION

Overview

Foundation

in **1987**

IPO at TWSE

in **2000**

Quality System Certificated

ISO 9001 ISO14001
QS 9000 IATF16949

Capacity

4000

Million chips per month

Location

4

Fabrication

Employees

900



ACE Royal Tech Inc.

T. 031-905-0968 F.02-6230-9269

<http://www.aceroyal.co.kr>

e-mail; marketing@aceroyal.co.kr



鼎元光電科技股份有限公司
TYNTEK CORPORATION

Locations

- Kejung Plant (Taiwan)
 - Executive office
 - 6" Inch Silicon Devices Wafer Fabrication
- Renai Plant (Taiwan)
 - Compound and Silicon Devices Wafer Fabrication
- Hsinchu Plant (Taiwan)
 - Compound Fiber-Optical Devices Wafer Fabrication
- Wuhan Plant (China)
 - Compound and Silicon Devices Chip Fabrication



ACE Royal Tech Inc.

T. 031-905-0968 F.02-6230-9269
<http://www.aceroyal.co.kr>
e-mail; marketing@aceroyal.co.kr



鼎元光電科技股份有限公司
TYNTEK CORPORATION

Main Product Lines



Compound LED Device

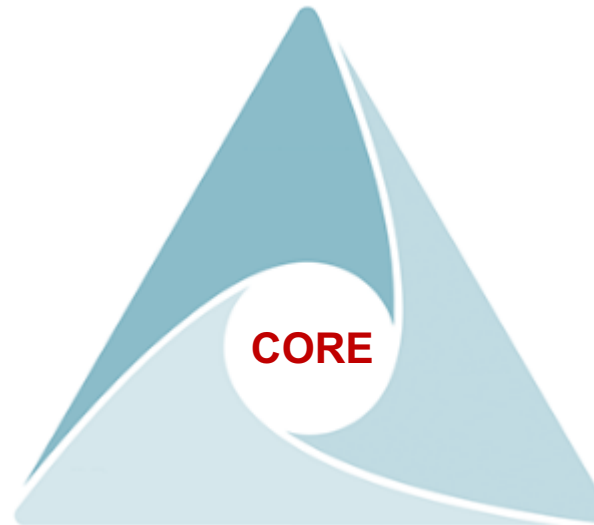

Silicon Device

Fiber-Optical
Communication



ACE Royal Tech Inc.

T. 031-905-0968 F.02-6230-9269
<http://www.aceroyal.co.kr>
e-mail; marketing@aceroyal.co.kr



鼎元光電科技股份有限公司
TYNTEK CORPORATION

Key Products

- **Visible LED Chips**
- **Infrared LED Chips**
- **Photo Diode / Transistor**
- **Zener Diode**
- **Fiber Optic Communication**



ACE Royal Tech Inc.

T. 031-905-0968 F.02-6230-9269
<http://www.aceroyal.co.kr>
e-mail; marketing@aceroyal.co.kr



鼎元光電科技股份有限公司
TYNTEK CORPORATION

Products of LED Compound Device

■ VISIBLE EMITTER

GaP	Red, Green LED
GaAsP	Yellow, Orange, Red LED
AlGaAs	SH, DH, DDH high brightness Red LED
AlGaInP	Yellow Green, Yellow, Orange, Red, high brightness As-Type, Wafer Bonding Red , Yellow LED

■ INFRARED EMITTER

GaAs/GaAs	940nm IRED LED
AlGaAs/GaAs	940nm IRED LED
AlGaAs/GaAs	850nm , 940nm VCSEL
AlGaAs/AlGaAs	730~910nm , high power /speed IR LED
AlGaAs/Si	730~940nm Wafer Bonding IR LED



ACE Royal Tech Inc.

T. 031-905-0968 F. 02-6230-9269
<http://www.aceroyal.co.kr>
e-mail: marketing@aceroyal.co.kr



鼎元光電科技股份有限公司
TYNTEK CORPORATION

Visible LED CHIPS

- Middle and small current application
- Chip size : < 0.3mm Driving Current < 50 mA

GaP	Red, Green
GaAsP	Yellow, Soft Orange, Orange, Red Orange
AlGaAs	SH, DH, DDH high brightness Red
AS AlGaInP	Yellow Green, Yellow, Orange, Red, high brightness Chips

Package type :

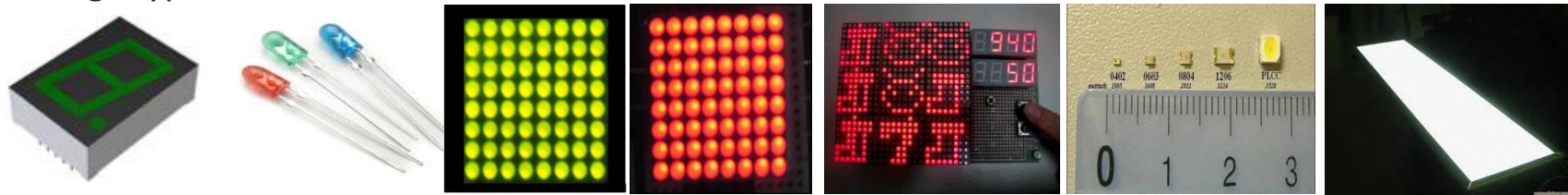

Digital display 3/5 mm indicator Dual color matrix Matrix display SMD Backlight

End application :



Temperature digital display Indicator for equipment Indoor outdoor display Car use color display



ACE Royal Tech Inc.
T. 031-905-0968 F.02-6230-9269
<http://www.aceroyal.co.kr>
e-mail; marketing@aceroyal.co.kr



鼎元光電科技股份有限公司
TYNTEK CORPORATION

Visible LED CHIPS

- Middle and large current application
- Chip size : 0.3mm – 1mm, Driving Current > 50 mA

AlGaAs DDH high brightness Red
 AS AlGaInP Yellow Green, Yellow, Orange, Red, high brightness Chips
 WB AlGaInP/Si Wafer Bonding Red ,Yellow.

Package type :



Outdoor full color Lamp



Piranha



SMD/PLCC



High power K1



Backlight

End application :

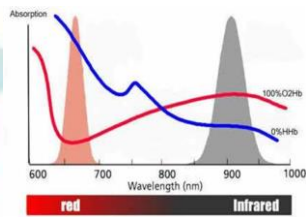
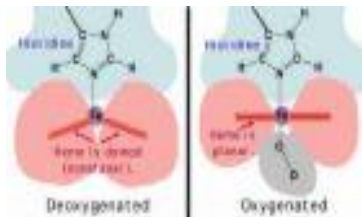

Absorption Spectrum for Oximeter on 660nm



Plant growth lamp



Car stop/break lamp



Outdoor full color display



ACE Royal Tech Inc.

T. 031-905-0968 F. 02-6230-9269
<http://www.aceroyal.co.kr>
 e-mail: marketing@aceroyal.co.kr



鼎元光電科技股份有限公司
TYNTEK CORPORATION

Infrared LED CHIPS

- IR LED CHIPS --- Middle and small current application
- Chip size : < 0.5mm Driving Current < 350 mA DC

GaAs/GaAs	940nm IRED
AlGaAs/GaAs	940nm IRED
AlGaAs/AlGaAs	710, 730, 770, 810, 830, 890nm high power IRED Chips
AlGaAs/AlGaAs	850, 870, high power/speed IRED LED Chips
WB AlGaAs/Si	Wafer Bonding Infrared 850, 940nm IRED Chips .

Package type :

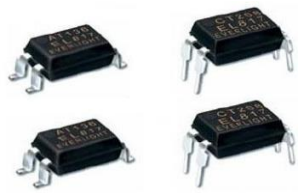

Photo coupler 940nm



Photo receiving module



Photo emitter



5 mm Lamp

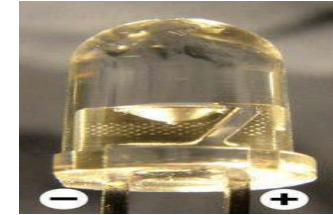

Bullet Lamp

End application :



TV Remote control
940nm



IrDA signal transmission
870nm



Mobile proximity sensor
850nm/940nm

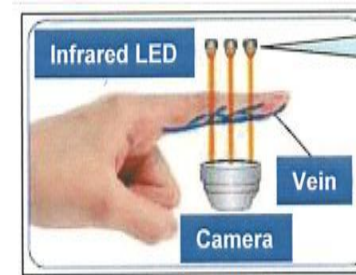

Vein identification
770nm



TV Remote control
940nm



ACE Royal Tech Inc.

T. 031-905-0968 F. 02-6230-9269
<http://www.aceroyal.co.kr>
 e-mail: marketing@aceroyal.co.kr



鼎元光電科技股份有限公司
 TYNTEK CORPORATION

Products of Silicon Device

■ Photodiode

PIN	Remote-control / Ambient / Proximity / Color Safety / Automotive / Medical / VCSEL MPD
NIP	Touch screen / Remote-control / Safety
ARRAY	Linear sensor / Safety / Automotive / VCSEL MPD
MATRIX	2D / 3D / Angular / Color / Safety/Automotive

■ Photo Transistor

SINGLE	Ambient / Proximity / Color sensor / Safety / Automotive
TWIN	Position / Color sensor / Safety / Automotive
ARRAY	Linear sensor
MATRIX	Angular / Color sensor



ACE Royal Tech Inc.

T. 031-905-0968 F. 02-6230-9269

<http://www.aceroyal.co.kr>

e-mail: marketing@aceroyal.co.kr



鼎元光電科技股份有限公司
TYNTEK CORPORATION

Spectrum Range of Silicon Sensors

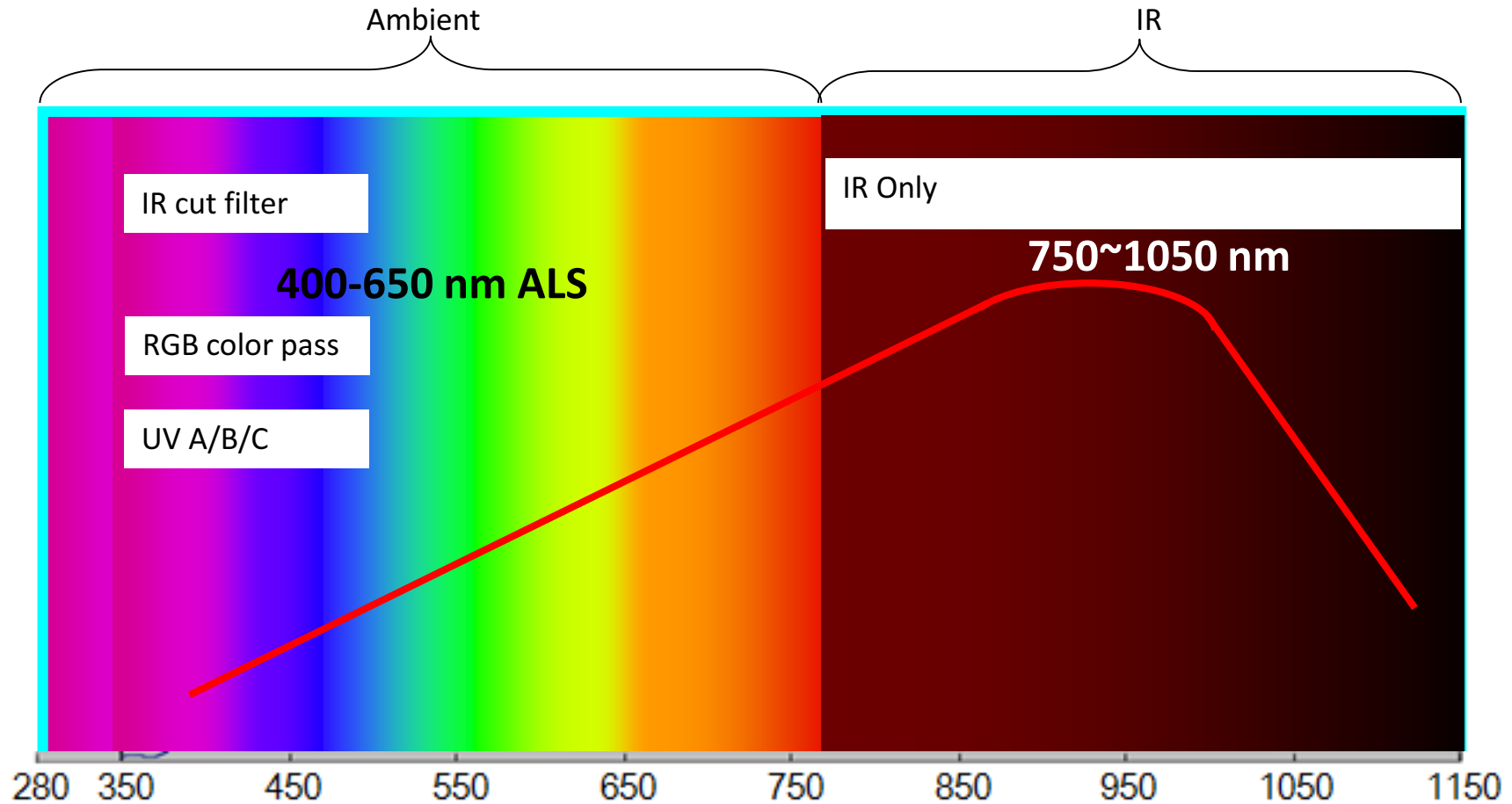

ACE Royal Tech Inc.

T. 031-905-0968 F.02-6230-9269

<http://www.aceroyal.co.kr>

e-mail; marketing@aceroyal.co.kr



鼎元光電科技股份有限公司
TYNTEK CORPORATION

Regular Package Form for PD & PT



Lamp



SMD



SMD



SMD



IRM



IRM



SMD

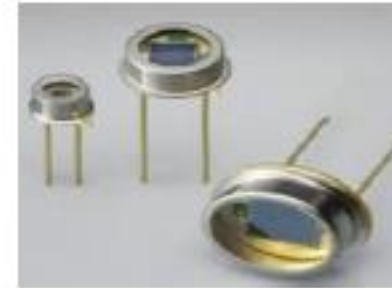

TO Type



ACE Royal Tech Inc.

T. 031-905-0968 F. 02-6230-9269

<http://www.aceroyal.co.kr>

e-mail: marketing@aceroyal.co.kr



鼎元光電科技股份有限公司
TYNTEK CORPORATION

Photoelectric Sensors Applications



• Touch Panel



• Sweeping Robot



• Smoke Detector



• Ambient Light Sensor



• Photo Mechanic Keyboard



ACE Royal Tech Inc.

T. 031-905-0968 F.02-6230-9269

<http://www.aceroyal.co.kr>

e-mail; marketing@aceroyal.co.kr



鼎元光電科技股份有限公司
TYNTEK CORPORATION

Products of Silicon Device

■ Zener Diode & TVS

SINGLE
TWIN
ARRAY
MATRIX

ESD / Surge Protection
Leakage Detection / voltage regulation



ACE Royal Tech Inc.

T. 031-905-0968 F.02-6230-9269

<http://www.aceroyal.co.kr>

e-mail; marketing@aceroyal.co.kr



鼎元光電科技股份有限公司
TYNTEK CORPORATION

Regular package type for Zener Diodes

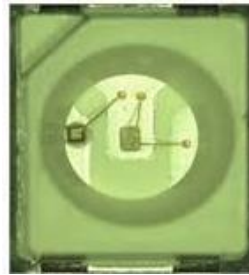
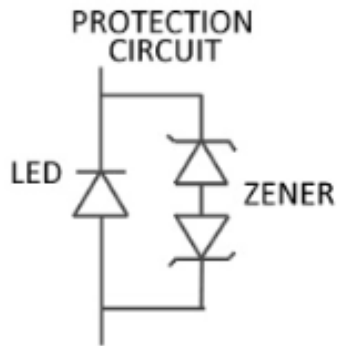

LED with Zener

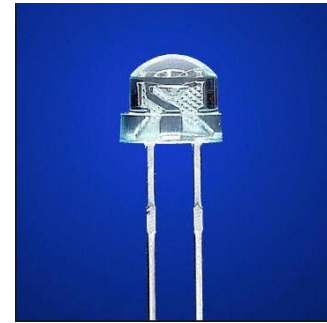

Lamp Type



SMD Type



COB Type



ESD Component

ACE Royal Tech Inc.
T. 031-905-0968 F.02-6230-9269
<http://www.aceroyal.co.kr>
e-mail: marketing@aceroyal.co.kr

鼎元光電科技股份有限公司
TYNTEK CORPORATION

Products of Fiber-Optic Communication Device

■ Infrared Detector

- InGaAs/InP 2.5G PIN PD & 2.5G APD
- InGaAs/InP 10G PIN PD(STIA/ LTE) & 10G APD
- InGaAs/InP Monitor Photo Diode
- AlGaAs/GaAs 5G/10G/25G 850nm Photo Diode
- AlGaAs/GaAs 40G/100G 850nm Photo Diode Array
- VCSEL 10G/40G Array for DATA & AOC Application



ACE Royal Tech Inc.

T. 031-905-0968 F. 02-6230-9269

<http://www.aceroyal.co.kr>

e-mail: marketing@aceroyal.co.kr



鼎元光電科技股份有限公司
TYNTEK CORPORATION

Package type for Fiber-Optic Communication

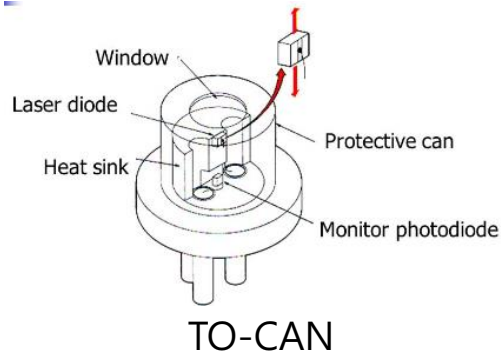

Chip & TO-CAN



Optical Transceiver module

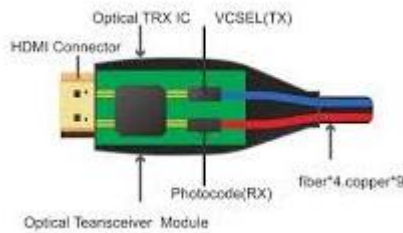

HDMI Optical Cable



Active Optical Cable



Fiber-Optic Communication Applications

PON Access Network

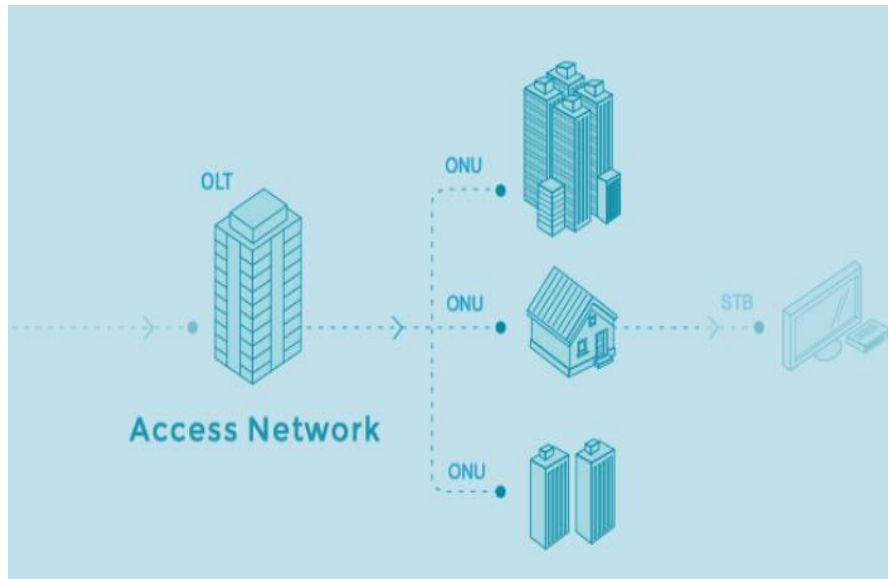

Data Center

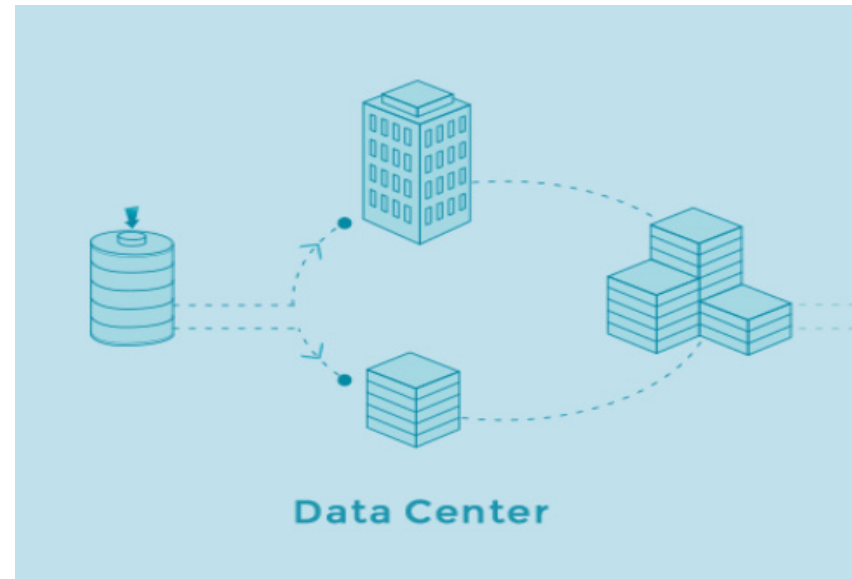

ACE Royal Tech Inc.

T. 031-905-0968 F. 02-6230-9269

<http://www.aceroyal.co.kr>

e-mail; marketing@aceroyal.co.kr



鼎元光電科技股份有限公司
TYNTEK CORPORATION

Driving Force for Potential Growth

- IoT / Smart Home / Smart City

- * IRED / VCSEL for LiFi
- * Photo Sensor for Medical / Safety / Environment Sensing

- IoC / Smart Car

- * IRED / VCSEL for Night Vision / LiDAR
- * Photo Sensor for Automotive Sensing
- * Power Device for Power Module

- IA / Smart Manufacturing

- * IRED / VCSEL for Emitter
- * Photo Sensor for Motion Control / Fully Automation
- * Power Device for Power Module

- 5G

- * Compound Fiber-Optical PD / APD for Monitoring / Receiver
- * VCSEL for Emitter



ACE Royal Tech Inc.

T. 031-905-0968 F. 02-6230-9269

<http://www.aceroyal.co.kr>

e-mail; marketing@aceroyal.co.kr



鼎元光電科技股份有限公司
TYNTEK CORPORATION



Thank You

July, 2018

<http://www.tyntek.com.tw>



ACE Royal Tech Inc.

T. 031-905-0968 F.02-6230-9269

<http://www.aceroyal.co.kr>

e-mail; marketing@aceroyal.co.kr



鼎元光電科技股份有限公司
TYNTEK CORPORATION